

United
States
of
America



To Promote the Progress



of Science and Useful Arts

The Director

of the United States Patent and Trademark Office has received an application for a patent for a new, original, and ornamental design for an article of manufacture. The title and description of the design are enclosed. The requirements of law have been complied with, and it has been determined that a patent on the design shall be granted under the law.

Therefore, this United States

Patent

grants to the person(s) having title to this patent the right to exclude others from making, using, offering for sale, or selling the design throughout the United States of America or importing the design into the United States of America for the term set forth by law.



DIRECTOR OF THE UNITED STATES PATENT AND TRADEMARK OFFICE



Maintenance Fee Notice

No maintenance fees are required in design patents.

Patent Term Notice

If the application for this patent was filed on or after May 13, 2015, the term of this patent is 15 years from the date of grant of this patent, subject to any disclaimer under 35 U.S.C. 253. If the application for this patent was filed prior to May 13, 2015, the term of this patent is 14 years from the date of grant of this patent, subject to any disclaimer under 35 U.S.C. 253.



USOD1099697S

(12) **United States Design Patent**
Simpson et al.

(10) **Patent No.:** **US D1,099,697 S**

(45) **Date of Patent:** **** Oct. 28, 2025**

(54) **CONTAINER**

(71) Applicant: **Mid-America Machining, Inc.**,
Brooklyn, MI (US)

(72) Inventors: **Matthew Simpson**, Tecumseh, MI
(US); **Peter Lobbestael**, Manitou
Beach, MI (US)

(73) Assignee: **Mid-America Machining, Inc.**,
Brooklyn, MI (US)

(**) Term: **15 Years**

(21) Appl. No.: **29/950,390**

(22) Filed: **Jul. 2, 2024**

(51) **LOC (15) Cl.** **09-01**

(52) **U.S. Cl.** **D9/524**
USPC

(58) **Field of Classification Search**
USPC D9/430-432, 500-503, 516, 520,
D9/522-524, 528-531, 541-545, 547,
D9/549-551, 553, 555, 557-560, 563,
D9/565-566, 571-575, 682, 686, 687,
D9/690, 693-694, 715, 719; D7/509-511
CPC ... B65D 1/00; B65D 1/02; B65D 1/12; B65D
1/18; B65D 1/20; B65D 1/0223; B65D
23/00; B65D 21/0237; B65D 2501/0009;
B65D 2501/0081; B65D 2543/00296;
B65D 2543/00092; B65D 41/26; B65D
2501/00

See application file for complete search history.

(56) **References Cited**

U.S. PATENT DOCUMENTS

D470,054 S * 2/2003 Gerhart D9/531
D475,297 S * 6/2003 Drabek D9/524
7,357,266 B2 * 4/2008 Giblin B65D 25/42
215/261

(Continued)

Primary Examiner — Omeed Agilee

(74) *Attorney, Agent, or Firm* — Honigman LLP; Eric J.
Sosenko; Jonathan P. O'Brien

(57) **CLAIM**

The ornamental design for a container, as shown and
described.

DESCRIPTION

FIG. 1 is a perspective view of a first embodiment of a
container in accordance with our new design

FIG. 2 is a front elevational of the container seen in FIG. 1;
FIG. 3 is a rear elevational view of the container seen in FIG.
1;

FIG. 4 is a left side elevational view of the container seen in
FIG. 1;

FIG. 5 is a right side elevational view of the container seen
in FIG. 1;

FIG. 6 is a top plan view of the container seen in FIG. 1;
FIG. 7 is a bottom plan view of the container seen in FIG.
1;

FIG. 8 is a perspective view of a second embodiment of a
container showing the new design;

FIG. 9 is a front elevational of the container seen in FIG. 8;
FIG. 10 is a rear elevational view of the container seen in
FIG. 8;

FIG. 11 is a left side elevational view of the container seen
in FIG. 8;

FIG. 12 is a right side elevational view of the container seen
in FIG. 8;

FIG. 13 is a top plan view of the container seen in FIG. 8;
and,

FIG. 14 is a bottom plan view of the container seen in FIG.
8.

The dashed lines in the drawings depict portions of the
container that form no part of the claimed design. The
dash-dot lines in the drawings define the bounds of the
claimed design and form no part thereof.

1 Claim, 12 Drawing Sheets

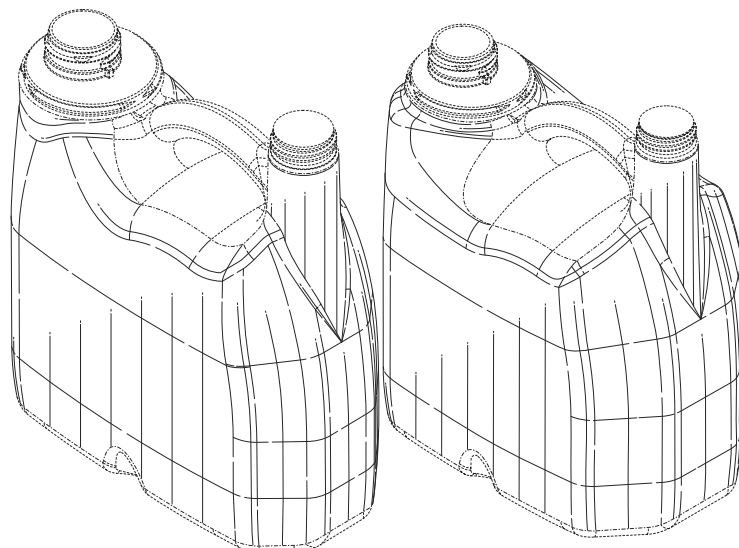

(56)

References Cited

U.S. PATENT DOCUMENTS

D608,206	S	*	1/2010	Kopulos	D9/524
D627,231	S	*	11/2010	Lee	D9/524
D643,297	S	*	8/2011	Lee	D9/524
D650,685	S	*	12/2011	Weaver	D9/524
D747,976	S	*	1/2016	Martin	D9/563
D842,113	S	*	3/2019	Sterling	D9/563
D850,270	S	*	6/2019	Berlepsch	D9/563
D851,491	S	*	6/2019	Sterling	D9/563
D873,143	S	*	1/2020	Berlepsch	D9/563
D883,104	S	*	5/2020	Castaing	D9/741
D887,275	S	*	6/2020	Bertram	D9/524
D891,255	S	*	7/2020	Berlepsch	D9/563

* cited by examiner

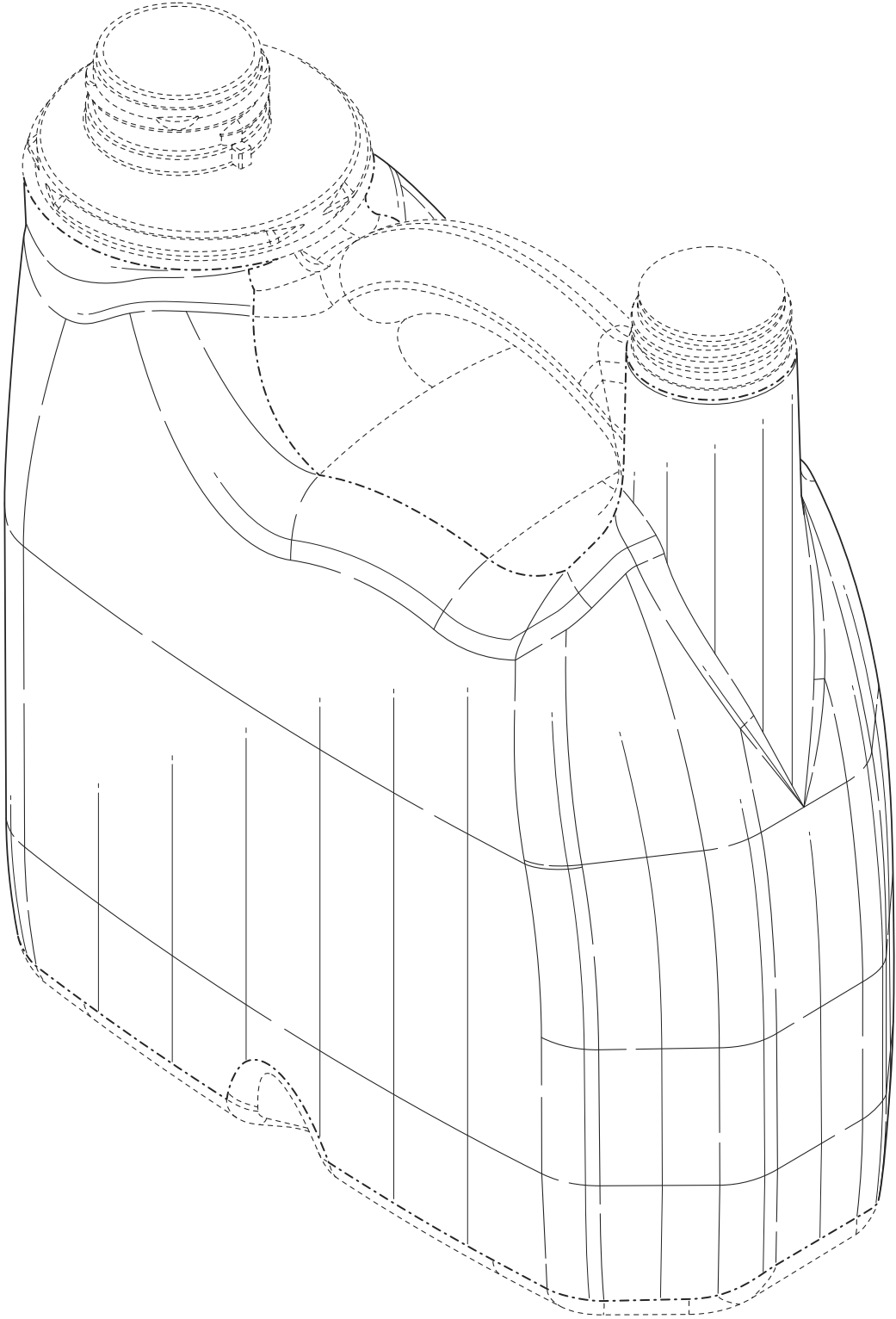

FIG. 1

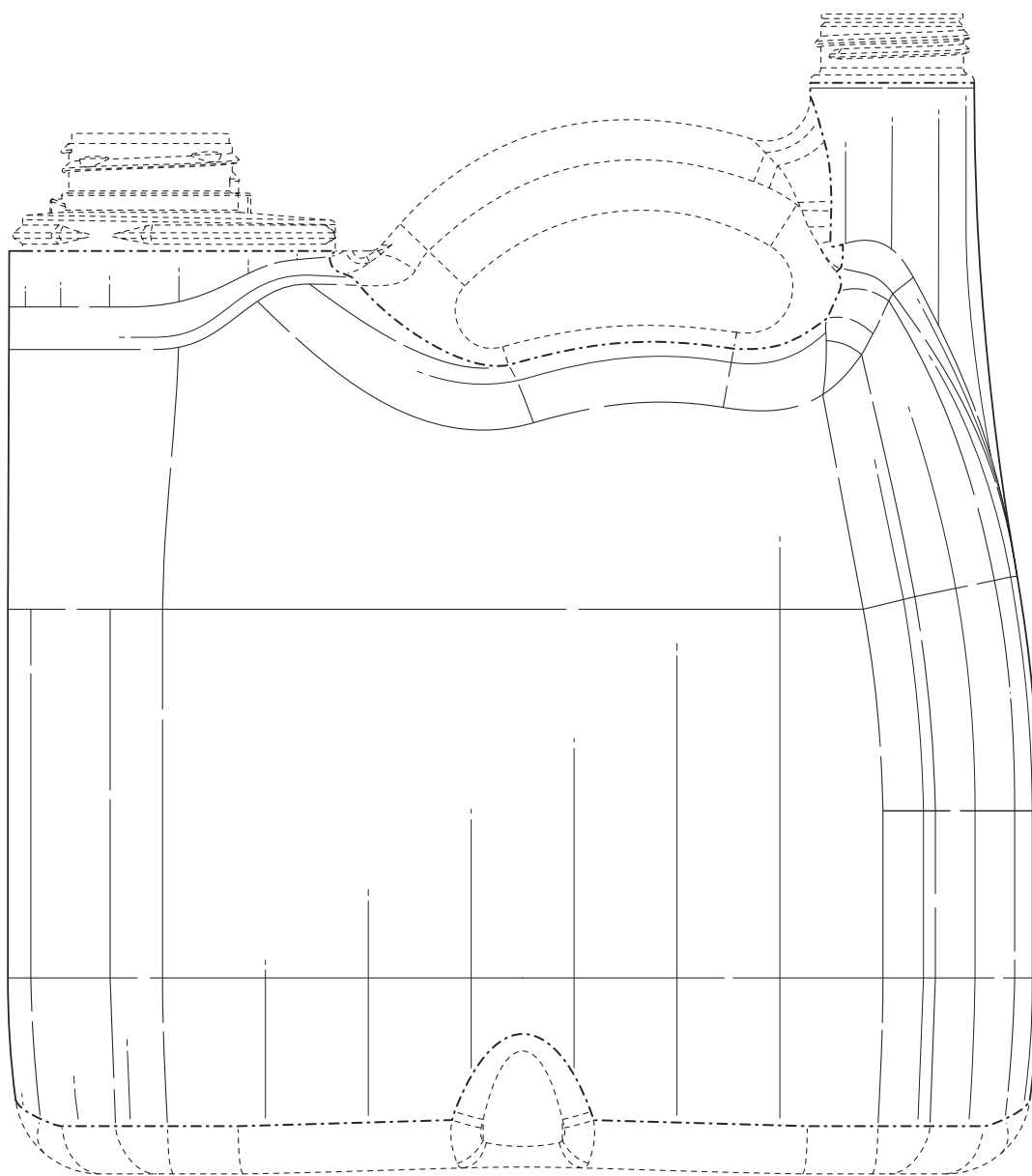

FIG. 2

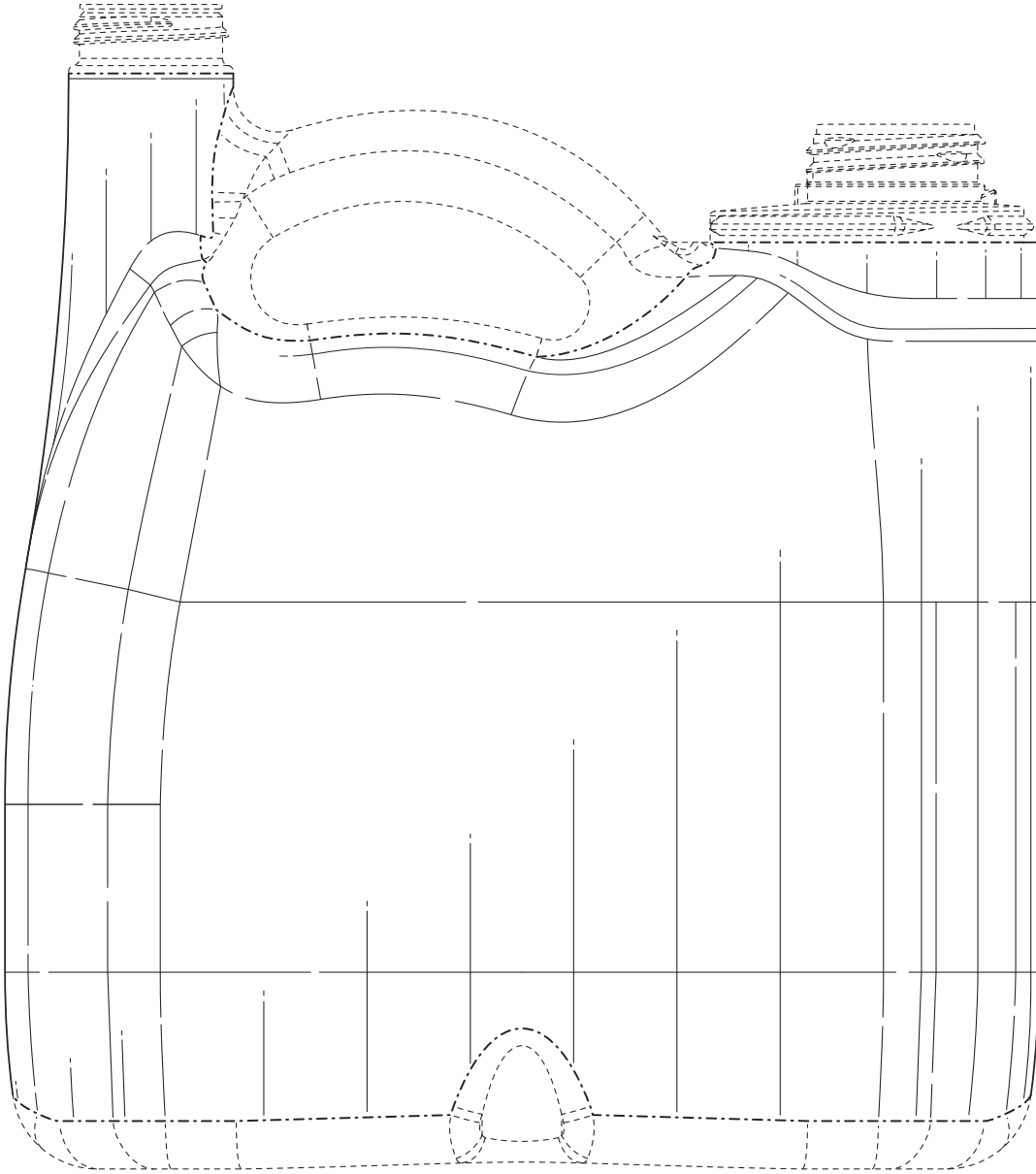

FIG. 3

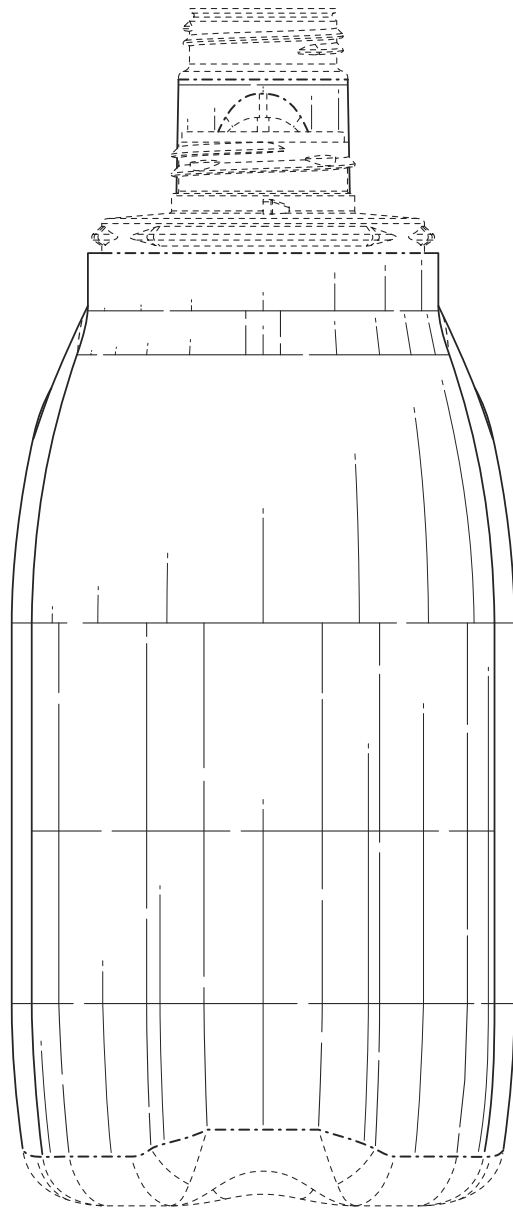

FIG. 4

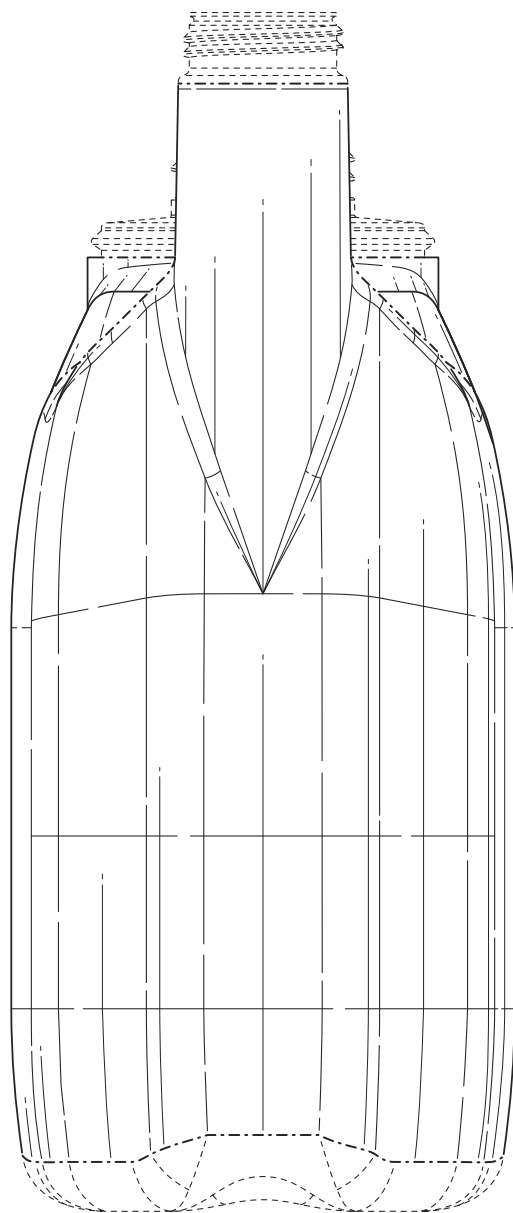

FIG. 5

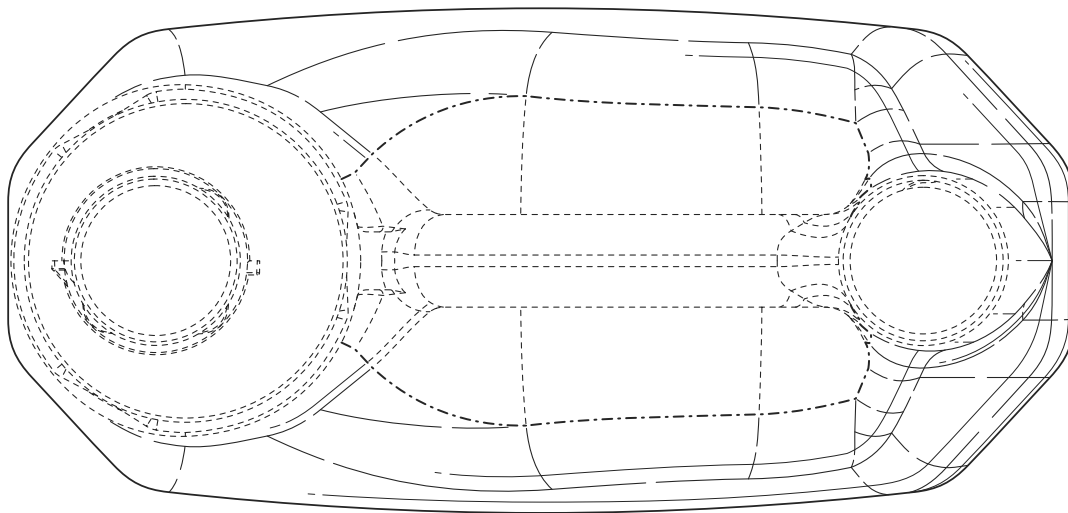

FIG. 6

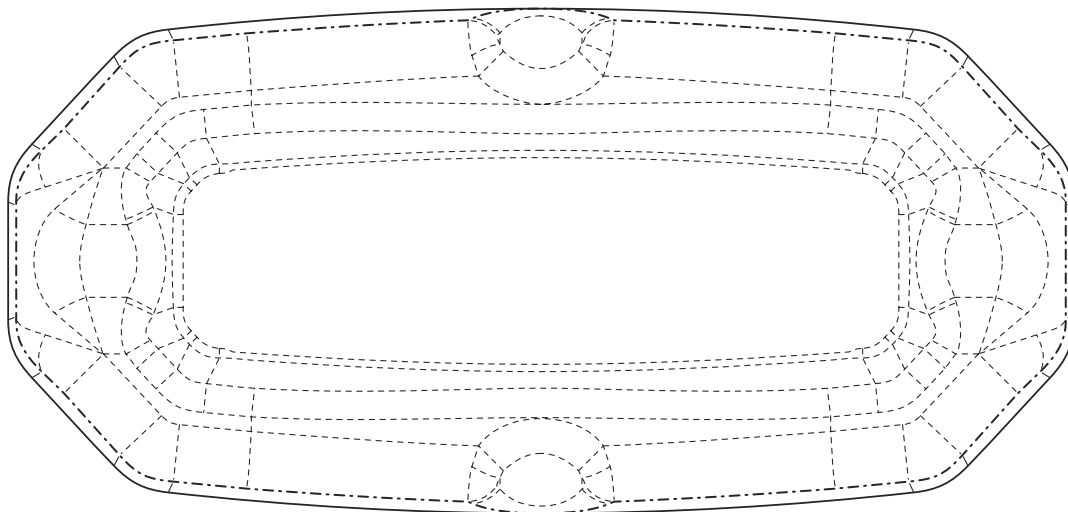

FIG. 7

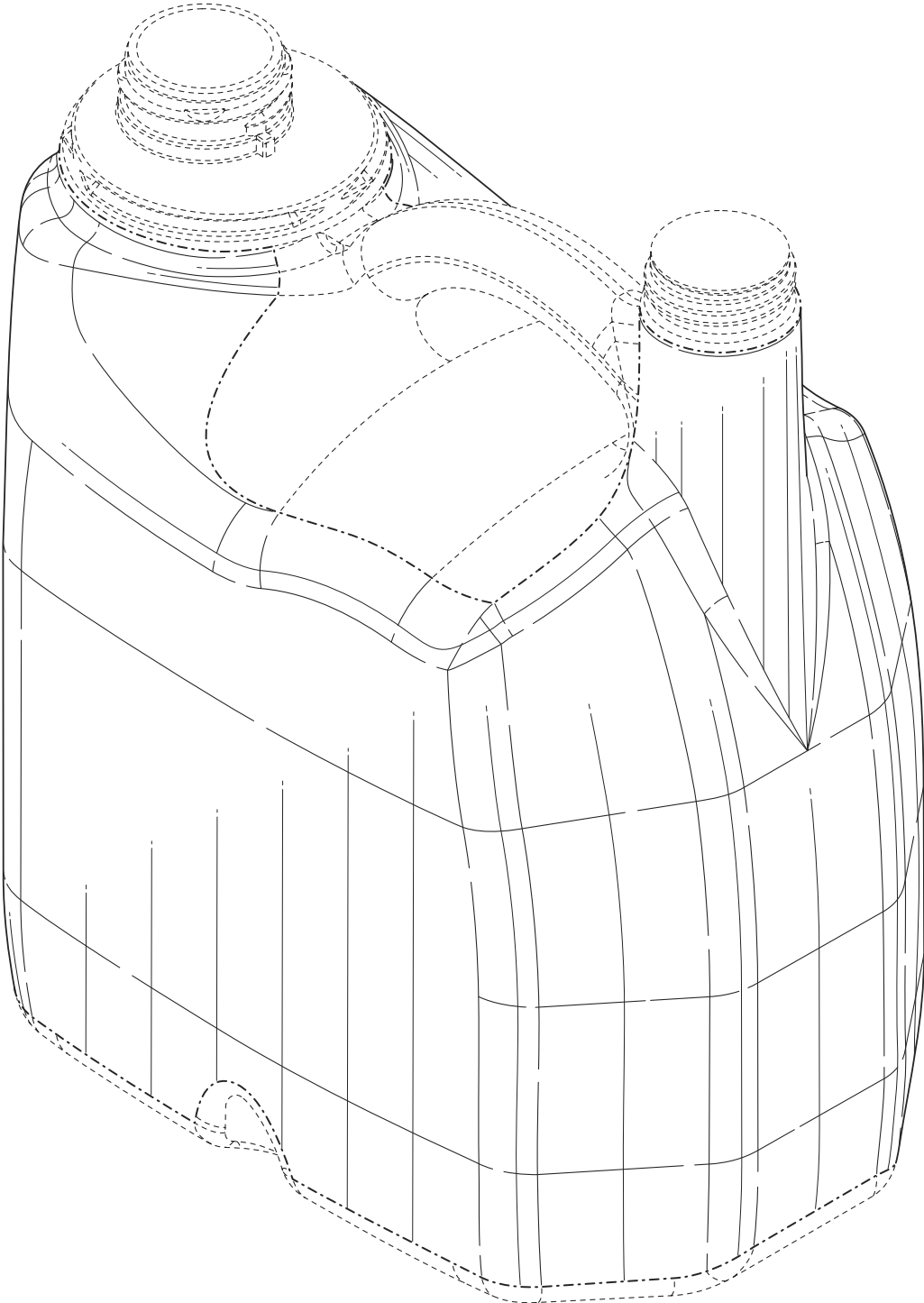

FIG. 8

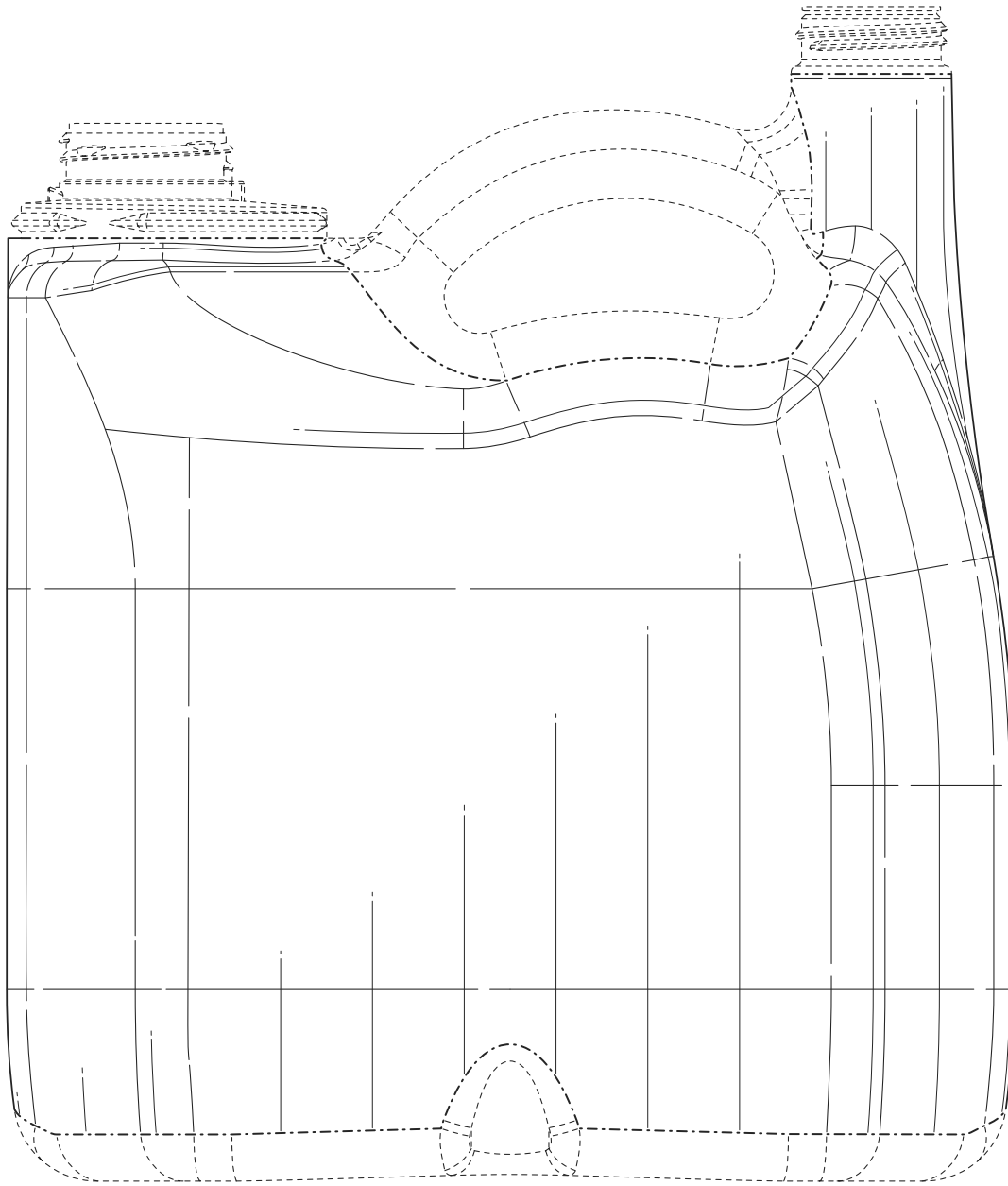

FIG. 9

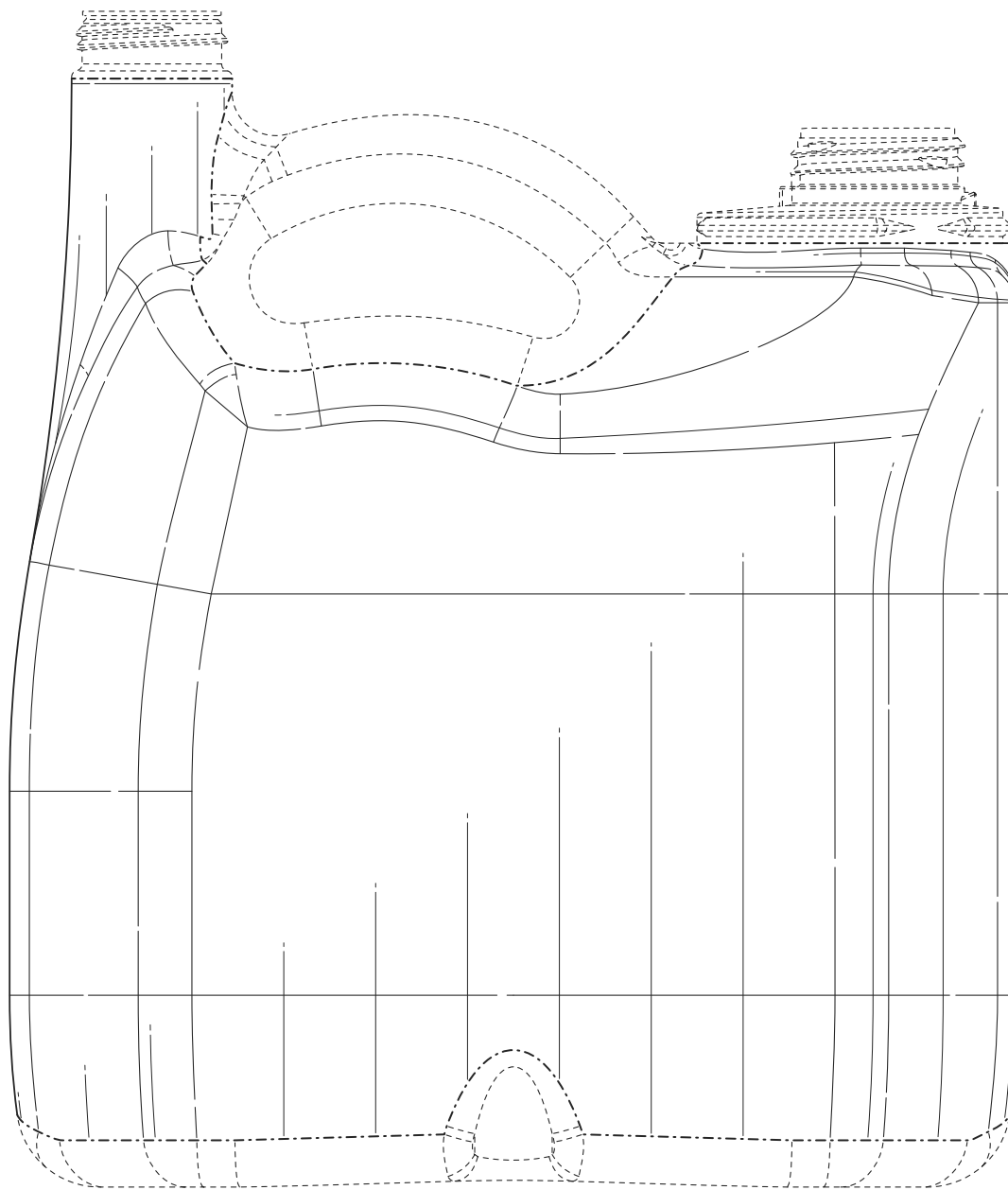

FIG. 10

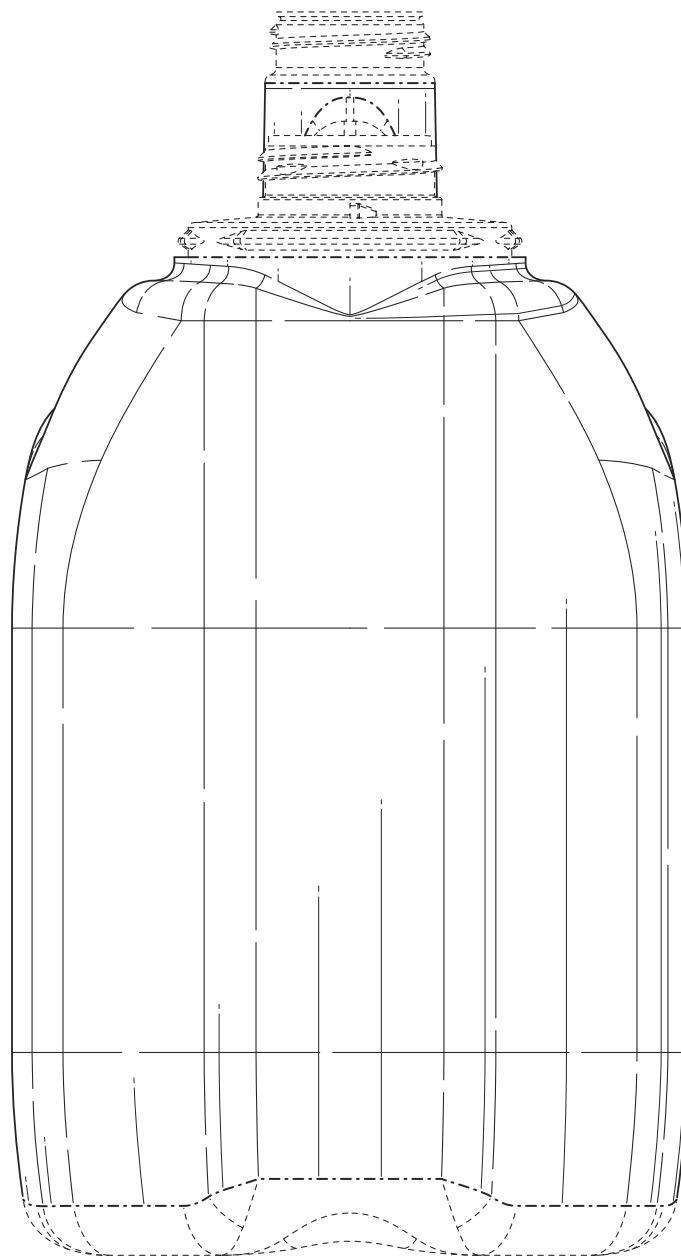

FIG. 11

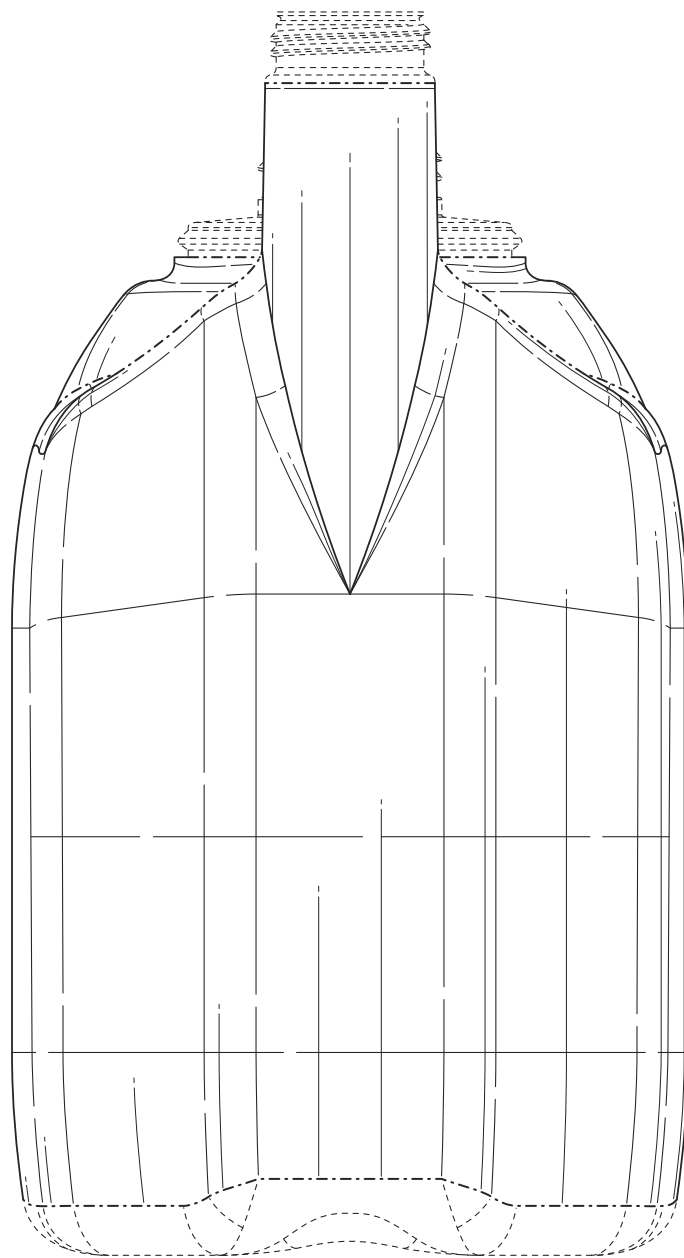

FIG. 12

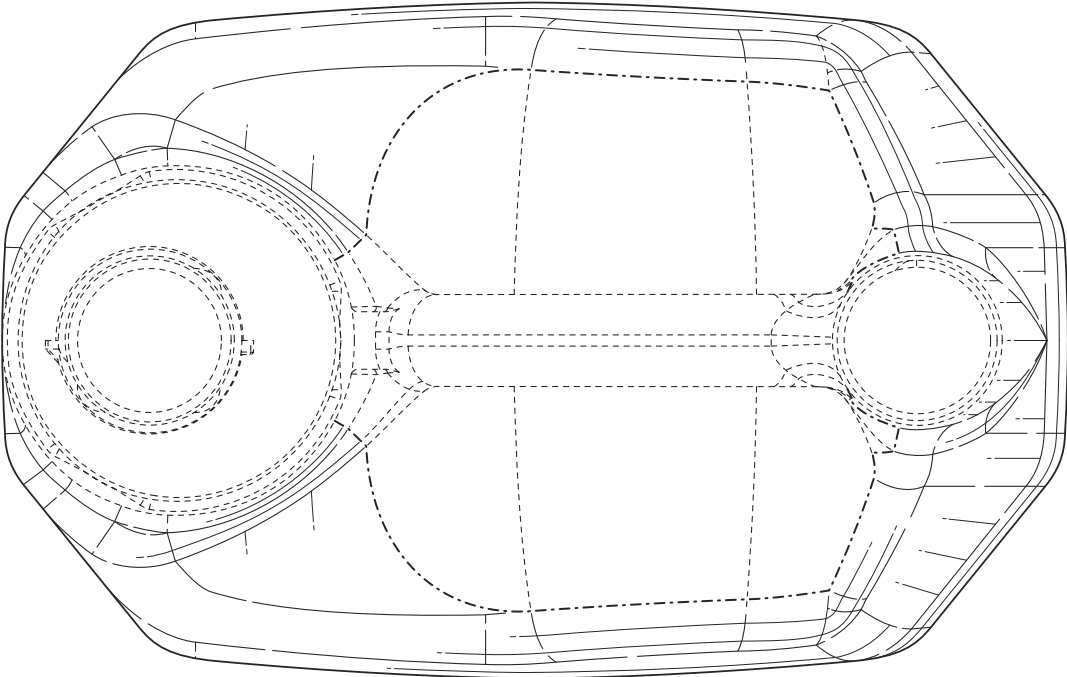

FIG. 13

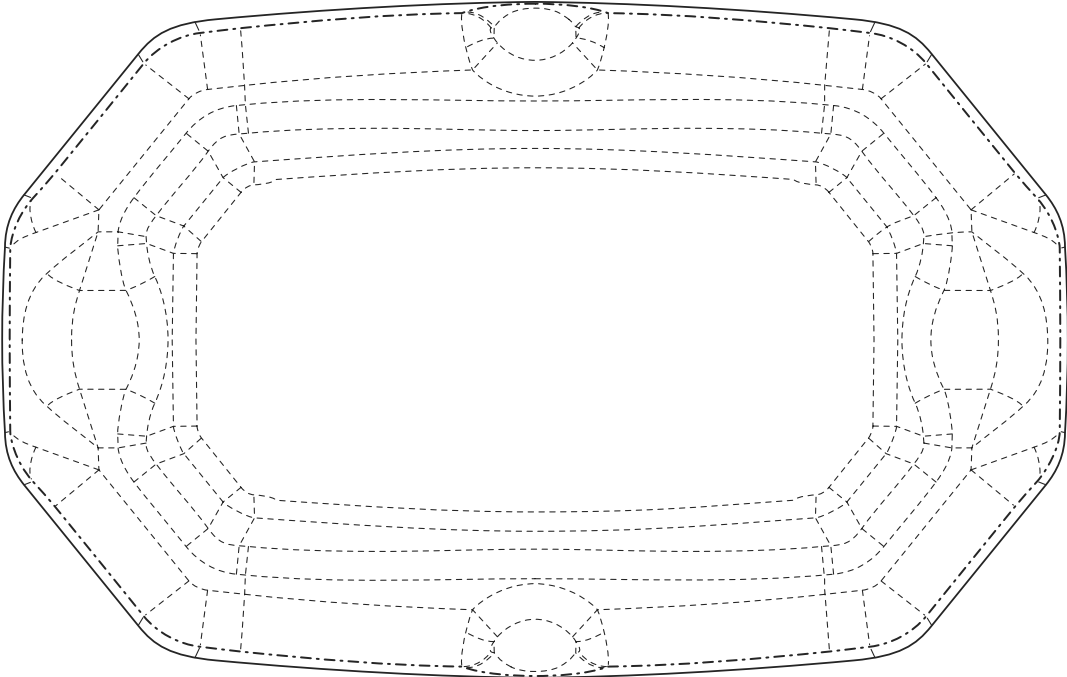

FIG. 14